

- EN** Installation / User Instructions / Warranty
FR Instructions de montage / Mode d'emploi / Garantie
ES Instrucciones de montaje / Manejo / Garantía

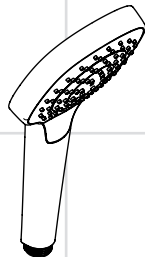

Cromo Select S Vario
26803xx1



Cromo Select E Vario
26813xx1
04726xx0

Technical Information

Flow rate

26803xx1, 26813xx1	2.5 GPM (9.5 l/min)
04726xx0	2.0 GPM (7.6 l/min)

Installation Considerations

- For best results, Hansgrohe recommends that this unit be installed by a licensed, professional plumber.
- Please read over these instructions thoroughly before beginning installation. Make sure that you have all tools and supplies needed to complete the installation.
- To prevent scald injury, the maximum output temperature of the shower mixing valve (not included) must be no higher than 120°F. In Massachusetts, the maximum output temperature can be no higher than 112° F.
- This showerhead is for use with automatic compensating valves rated at 2.5 GPM (9.5 l/min) or less.
- **#04726xx0 only:** This showerhead is for use with automatic compensating valves rated at 1.5 GPM (5.7 l/min) or less.
- Keep this booklet and the receipt (or other proof of date and place of purchase) for this product in a safe place. The receipt is required should it be necessary to request warranty parts.

Données techniques

Capacité nominale

26803xx1, 26813xx1	2.5 GPM (9.5 l/min)
04726xx0	2.0 GPM (7.6 l/min)

À prendre en considération pour l'installation

- Pour de meilleurs résultats, Hansgrohe recommande que ce produit soit installé par un plombier professionnel licencié.
- Veuillez lire attentivement ces instructions avant de procéder à l'installation. Assurez-vous de disposer de tous les outils et du matériel nécessaires pour l'installation.
- Pour empêcher des blessures par ébouillatement, la température de sortie maximale du robinet de douche ne doit pas excéder 120°F. Au Massachusetts, la température de sortie maximale du robinet de douche ne doit pas excéder 112°F.
- Cette pomme de douche doit être utilisée avec une soupape qui compense automatiquement, et est évalué à 2.5 GPM (9.5 l/min) ou moins.
- **04726xx0 seulement:** Cette pomme de douche doit être utilisée avec une soupape qui compense automatiquement, et est évalué à 1.5 GPM (5.7 l/min) ou moins.
- Conservez ce livret et le reçu (ou une autre preuve sur laquelle figurent la date et l'endroit de l'achat) pour ce produit dans un endroit sûr. Le reçu est requis si vous commandez des pièces sous garantie.

Datos técnicos

Caudal máximo

26803xx1, 26813xx1 2.5 GPM (9.5 l/min)
 04726xx0 2.0 GPM (7.6 l/min)

Consideraciones para la instalación

- Para obtener mejores resultados, la instalación debe estar a cargo de un plomero profesional matriculado.
- Antes de comenzar la instalación, lea estas instrucciones detenidamente. Asegúrese de tener las herramientas y los insumos necesarios para completar la instalación.
- Para evitar escaldaduras, la máxima temperatura de salida de la válvula de la ducha no debe exceder los 120°F. En Massachusetts, la máxima temperatura de salida de la válvula de la ducha no debe exceder los 112°F.
- Esta ducha cabezal debe ser utilizada con una válvula que compensa automáticamente, y es valorado en 2.5 GPM (9.5 l/min) o menos.
- **Nº 04726xx0 solamente:** Esta ducha cabezal debe ser utilizada con una válvula que compensa automáticamente, y es valorado en 1.5 GPM (5.7 l/min) o menos.

- Mantenga este folleto y el recibo (u otro comprobante del lugar y fecha de compra) de este producto en lugar seguro. El recibo se requiere en caso de ser necesario solicitar piezas bajo garantía.

Croma Select S

26803xx1

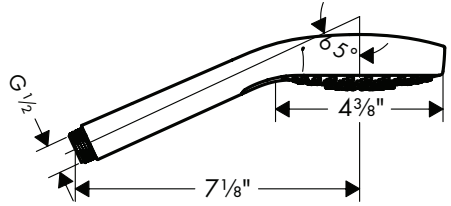

Croma Select E

26813xx1

04726xx0

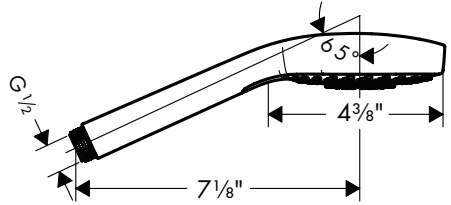

Models 26803xx1, 26813xx1

This unit meets or exceeds the following:

- ASME A112.18.1 / CSA B125.1
- Listed by CSA for use in the US and Canada

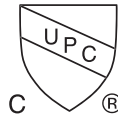

Model 04726xx0

This unit meets or exceeds the following:

- ASME A112.18.1 / CSA B125.1
- Listed by IAPMO for use in the US and Canada
- Watersense certified



Installation / Installation / Instalación

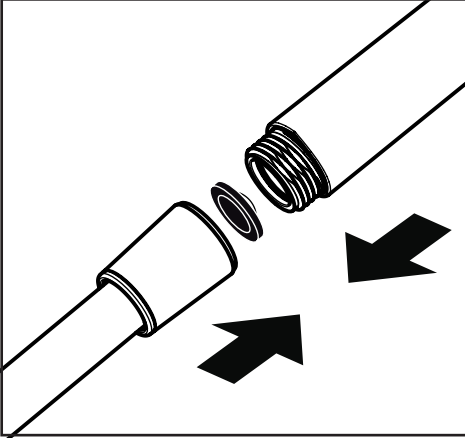

User Instructions / Instructions de service / Manejo

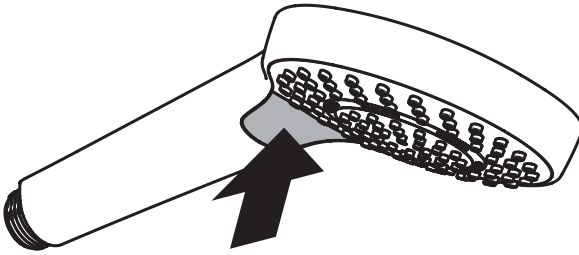



TurboRain

IntenseRain

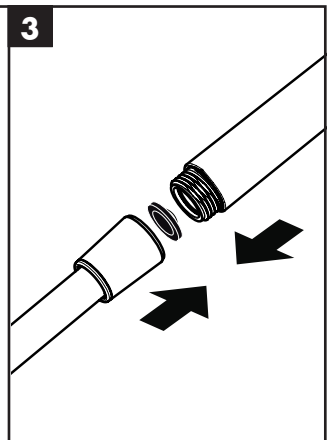
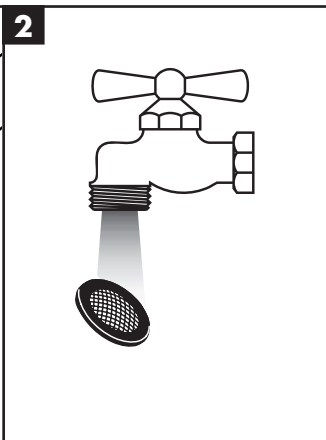
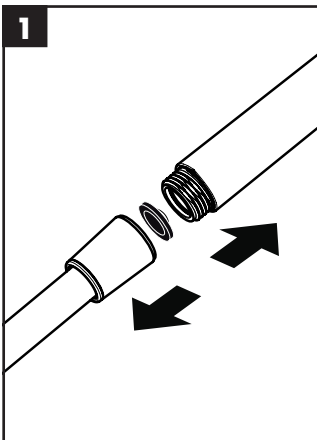
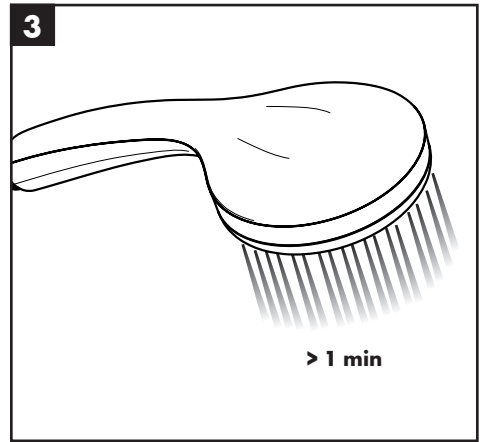
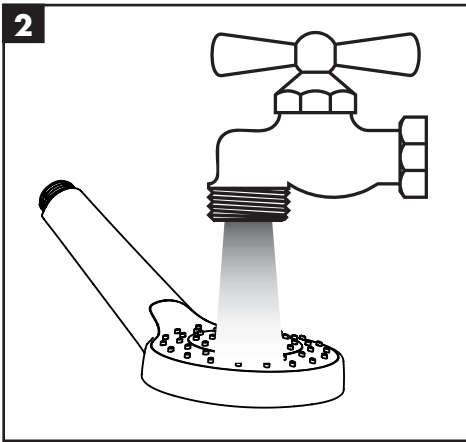
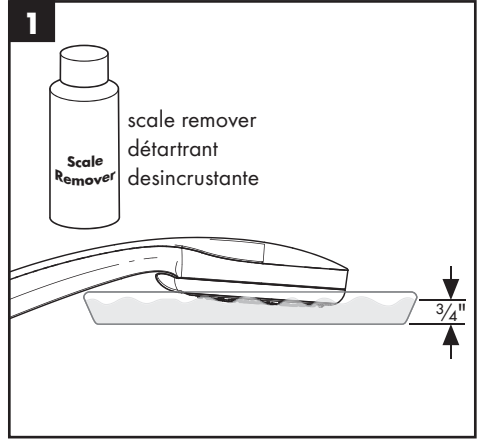
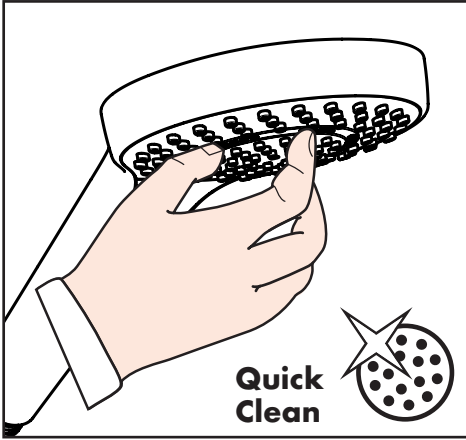
Rain

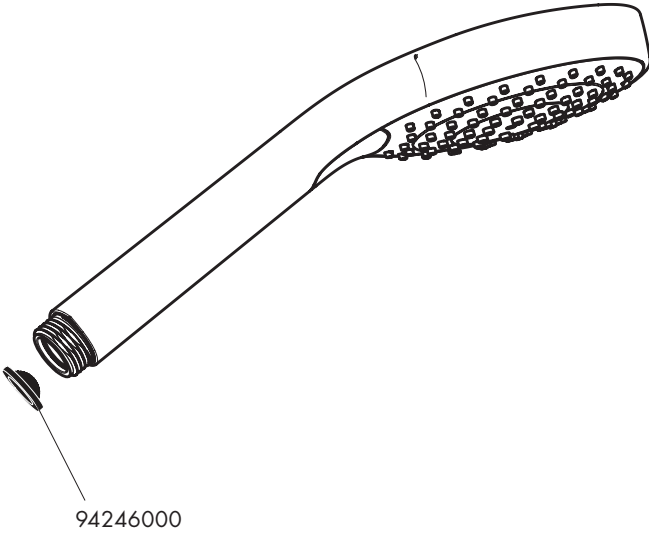



Cleaning Recommendation for Hansgrohe Products

Modern bathroom faucets, kitchen faucets and shower products are made from different materials to comply with the needs of the market with regard to design and functionality. To avoid damage to the product, it is necessary to take proper care of it.

For best results:

- Prevent the buildup of mineral scale and /or soap residue by cleaning your Hansgrohe product(s) when needed.
- Select a cleaning agent specifically intended for the type of product.
- **Do not** use these types of cleaners as they will cause damage to your Hansgrohe product:
 - ✗ Any cleaning agent containing hydrochloric acid, formic acid, lye, or acetic acid.
 - ✗ Abrasive cleaning powders, pads, or brushes.
 - ✗ Steam cleaners.
 - ✗ "No rinse" cleaning agents.
- **Always** follow the instructions provided by the manufacturer of the cleaning agent.
- **Do not** mix cleaning agents, unless directed by the manufacturer.
- **Do not** spray cleaners directly onto the product as drops could enter openings and gaps and cause damage. When using spray cleaners, spray the cleaner onto a soft cloth or sponge.
- **Always** rinse your Hansgrohe product thoroughly with clear water and polish dry with a soft cloth after cleaning.

Important

- Residue from soaps and shampoos can cause damage. Rinse the product with clean water after each use.
- Residue from basin/tub/tile cleaner can cause damage to faucets and fittings. Immediately rinse any overspray from the Hansgrohe product.
- **Damage to the product caused by improper care or the use of improper cleaning agents is not covered by the warranty.**
- **If a component of the product is damaged, replace it, as there is risk of injury.**

Conseil de nettoyage pour les produits Hansgrohe

Les robinets pour les salles de bains et les cuisines modernes ainsi que les produits récents pour les douches se composent de matériaux différents afin de satisfaire aux besoins du marché en termes de conception et de fonctionnalité. Afin d'éviter d'endommager le produit, il est nécessaire d'en prendre soin.

Pour de meilleurs résultats :

- Empêchez l'accumulation de tarte et/ou de résidu de savon en nettoyant votre produit Hansgrohe lorsque c'est nécessaire.
- Sélectionnez un produit de nettoyage spécifiquement prévu pour ce type de produit.
- **N'utilisez pas** ces types de nettoyants car ils peuvent endommager votre produit Hansgrohe :
 - ✗ Tout produit de nettoyage contenant de l'acide chlorhydrique, de l'acide formique, de la potasse ou de l'acide acétique.
 - ✗ Les poudres de nettoyage, les tampons ou les brosses abrasives.
 - ✗ Les nettoyeurs à vapeur.
 - ✗ Les produits de nettoyage « sans rinçage ».
- **Ne mélangez pas** les produits de nettoyage, à moins que cela soit indiqué par le fabricant.
- **Ne pulvérisez pas** les nettoyants directement sur le produit car des gouttes pourraient entrer dans les ouvertures et les fentes et causer des dommages. Lorsque vous utilisez des nettoyants par pulvérisation, pulvérisez le nettoyage sur un chiffon ou une éponge douce.

Important

- Les résidus de produits pour le corps comme les savons liquides, shampoings, gels de douche, teintures pour cheveux, parfums, après-rasage et vernis à ongles peuvent causer des détériorations. Rincez le produit avec de l'eau propre après chaque utilisation.
- Le résidu provenant des nettoyeurs pour cuvette/baignoire/carrelage peut endommager les robinets et les raccords de tuyauterie. Rincez immédiatement toute surpulvérisation sur le produit Hansgrohe.
- De même, il est interdit de stocker des détergents ou des produits chimiques sous les produits, par ex. dans un meuble sous lavabo, car les vapeurs qui s'en dégagent risquent d'abîmer les produits.
- **Les dommages au produit causés par un mauvais entretien ou par l'utilisation de produits de nettoyage inadéquats ne sont pas couverts par la garantie.**
- **Si un composant du produit est endommagé, remplacez-le, car il existe un risque de blessure.**

Recomendación de limpieza para los productos de Hansgrohe

Hoy en día, las griferías de baño y de cocina así como duchas modernas se componen de materiales muy distintos para satisfacer las exigencias del mercado respecto al diseño y la funcionalidad. Para evitar daños y reclamaciones hay que tener en cuenta ciertos aspectos tanto en el uso como en su limpieza.

Para obtener mejores resultados:

- Evite la acumulación de restos de jabón o sarro limpiando el producto Hansgrohe cuando sea necesario.
- Seleccione un agente de limpieza diseñado específicamente para el tipo de producto.
- **No** use estos tipos de limpiadores, ya que causarán daño a su producto Hansgrohe:
 - ✗ Agentes limpiadores que contengan ácido clorhídrico, fórmico, acético o lejía.
 - ✗ Polvos, paños o cepillos de limpieza abrasivos.
 - ✗ Limpiadores a vapor
 - ✗ Agentes de limpieza "sin enjuague".
- **Siempre** siga las instrucciones provistas por el fabricante del agente de limpieza.
- **No** mezcle los agentes de limpieza, a menos que esté indicado por el fabricante.
- **No** rocíe limpiadores directamente sobre el producto, ya que podrían caer gotas sobre las aberturas y espacios y causar daños. Cuando use limpiadores en spray, rocíe el limpiador sobre un paño suave o esponja.
- **Siempre** enjuague su producto Hansgrohe con agua limpia y séquelo y lustrelo con un paño suave después de la limpieza.

Importante

- Los residuos de productos de aseo como jabón líquido, champú, gel de ducha, tintes de pelo, perfumes, lociones de afeitado y esmalte de uñas pueden dañar también los materiales. Enjuague el producto con agua limpia después de cada uso.
- Los residuos de limpiadores para lavatorios, bañeras o azulejos pueden causar daño a los grifos y accesorios. Enjuague inmediatamente cualquier derrame que haya sobre el producto de Hansgrohe.
- Tampoco pueden generarse depósitos de productos de limpieza o químicos debajo de los productos, p. ej. en un armario de lavabo. De lo contrario, los vapores generados pueden dañar los productos.
- **Los daños que resulten de un cuidado inadecuado o uso de agentes de limpieza inadecuados no están cubiertos por la garantía.**
- **Si se daña un componente del producto, reemplácelo, ya que existe riesgo de lesión.**

Limited Consumer Warranty

This warranty is limited to products manufactured by Hansgrohe, Inc. ("Hansgrohe") that are purchased by a consumer in the United States or Canada after March 1, 1996, and installed in either the United States or in Canada.

WHO IS COVERED BY THE WARRANTY

This limited warranty extends to the original purchaser only. This warranty is non-transferable. Hansgrohe neither assumes nor authorizes any person to create for it any other obligation or liability in connection with this product.

LENGTH OF WARRANTY

If you are a consumer who purchased the product for use primarily for personal, family or household purposes, this limited warranty starts on the date of purchase and extends for as long as you own the product and the home in which the product is originally installed. If you purchased the product for use primarily for any other purpose, including, without limitation, a commercial purpose, this limited warranty starts on the date of purchase and extends (i) for 1 year, with respect to Hansgrohe and Commercial products, and (ii) for 5 years, with respect to Axor products. The Rubbed Bronze finish is subject to a 3-year limited warranty starting on the date of purchase.

WHAT IS COVERED BY THE WARRANTY

This limited warranty covers only your Hansgrohe manufactured product. Hansgrohe warrants this product against defects in material or workmanship as follows:

Hansgrohe will replace at no charge for parts only or, at its option, replace any product or part of the product that proves defective because of improper workmanship and/or material, under normal installation, use, service and maintenance. If Hansgrohe is unable to provide a replacement and repair is not practical or cannot be made in timely fashion, Hansgrohe may elect to refund the purchase price in exchange for the return of the product. REPAIR OR REPLACEMENT (OR, IN LIMITED CIRCUMSTANCES, REFUND OF THE PURCHASE PRICE) AS PROVIDED UNDER THIS LIMITED WARRANTY IS THE EXCLUSIVE REMEDY OF THE PURCHASER.

WHAT IS NOT COVERED BY THE WARRANTY

- A. Conditions, malfunctions or damage not resulting from defects in material or workmanship.
- B. Conditions, malfunctions or damage resulting from (1) normal wear and tear, improper installation, improper maintenance, misuse, abuse, negligence, accident or alteration; (2) the use of abrasive or caustic cleaning agents or "no-rinse" cleaning products, or the use of the product in any manner

contrary to the product instructions; or (3) conditions in the home such as excessive water pressure or corrosion.

- C. Labor and other expenses for disconnection, deinstallation, or return of the product for warranty service (including but not limited to proper packaging and shipping costs), or for installation or reinstallation of the product.
- D. Accessories, connected materials and products, or related products not manufactured by Hansgrohe.
- E. Any Hansgrohe or Axor product sold for display purposes.

HANSGROHE SHALL NOT BE LIABLE TO PURCHASER OR ANY OTHER PERSON FOR ANY INCIDENTAL, SPECIAL OR CONSEQUENTIAL DAMAGES, ARISING OUT OF BREACH OF THIS LIMITED WARRANTY.

Some provinces and some states do not allow the exclusion or limitation of incidental or consequential damages, so the above limitation or exclusion may not apply to you.

TO OBTAIN WARRANTY PARTS OR INFORMATION

Contact your Hansgrohe retailer, or contact Technical Service at:

Hansgrohe, Inc.
1492 Bluegrass Lakes Parkway
Alpharetta, GA 30004
Toll-free 800-334-0455

In requesting warranty service, you will need to provide:

1. The sales receipt or other evidence of the date and place of purchase.
2. A description of the problem.
3. Delivery of the product or the defective part, postage prepaid and carefully packed and insured, to:

Hansgrohe, Inc.
1492 Bluegrass Lakes Parkway
Alpharetta, GA 30004
Toll-free 800-334-0455

When warranty service is completed, any repaired or replacement product or part will be returned to you postage prepaid. REVISED MAY 1, 2016.

PRODUCT INSTRUCTIONS AND QUESTIONS

Upon purchase or prior to installation, please carefully inspect your Hansgrohe product for any damage or visible defect. Prior to installing, always carefully study the enclosed instructions on the proper installation and the care and maintenance of this product. If you have questions at any time about the use, installation or performance of your Hansgrohe product, or this warranty, please write us or call us toll-free at 800-334-0455.

hansgrohe

Hansgrohe, Inc. • 1490 Bluegrass Lakes Parkway • Alpharetta, GA 30004
Tel. 800-334-0455 • Fax 770-889-1783

www.hansgrohe-usa.com