

Features

- Single-speed whirlpool offers performance and value, with 8 fully adjustable jets.
- Hydromassage flow and direction can be controlled at each jet.
- Molded lumbar support and armrests offer extra comfort while bathing.
- Integral apron.
- Integral flange helps prevent water from seeping behind wall and simplifies alcove installation.
- Textured bottom surface
- Right-hand drain.
- Coordinates with other products in the Devonshire collection.

Material

- Acrylic

Hydrotherapy

- Whirlpool

Installation

- Three-wall alcove.

Additional Hydrotherapy Options

- Soaking Bath - K-1184-RA
- Soaking Bath + Bask heated surface - K-1184-RAW
- BubbleMassage air bath - K-1357-GRA
- BubbleMassage air bath + Bask heated surface - K-1357-GRAW
- VibrAcoustic - K-1357-VBRA
- VibrAcoustic + Bask heated surface - K-1357-VBRAW
- Whirlpool - K-1357-RA
- Whirlpool + Bask heated surface - K-1357-RAW
- Whirlpool + heater - K-1357-HR

Recommended Products/Accessories

K-7161-AF Bath Drain
K-24916 Wireless Music Kit
K-7213 27" Cable Bath Drain
K-7214 27" Cable Bath Drain
K-7259 Clearflo Bath Drain
K-37380 30" Rough-in Cable Bath Drain
K-37383 30" Rough-in Cable Bath Drain
K-702200-G54 Frameless Sliding Bath Door
K-702200-G73 Frameless Sliding Bath Door
K-702200-L Frameless Sliding Bath Door
K-702205-L Frameless Sliding Bath Door



Codes/Standards

ASME A112.19.7/CSA B45.10
CSA B45.5/IAPMO Z124
ASTM E162
ASTM E662
UL 1795
CSA C22.2 No. 218.2





**KOHLER® Plastic Baths and Receptors
Lifetime Limited Warranty
KOHLER® Hydrotherapy Components
Five-Year Limited Warranty**

See website for detailed warranty information.

Available Colors/Finishes

Color tiles intended for reference only.

Color	Code	Description
-------	------	-------------

	0	White
	96	Biscuit
	47	Almond
	NY	Dune
	G9	Sandbar

No change in measurements if connected with drain illustrated. (K-7161-AF)

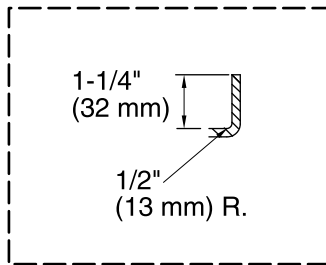

Integral Flange Detail

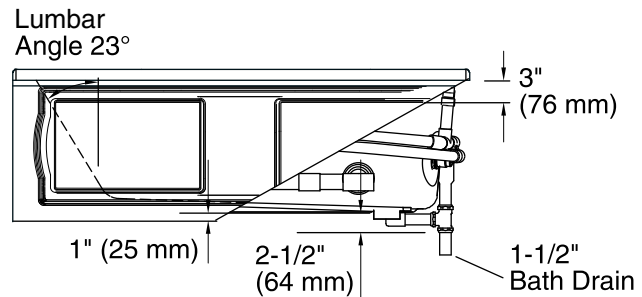
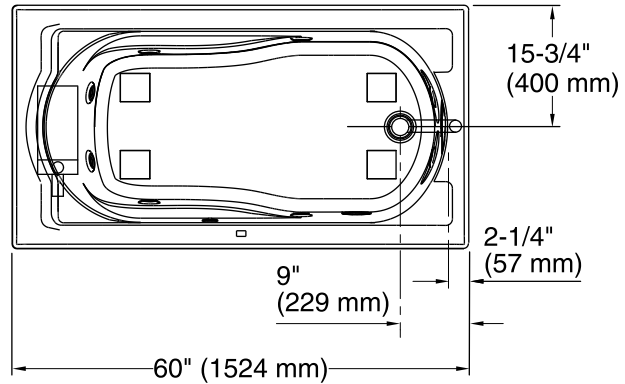
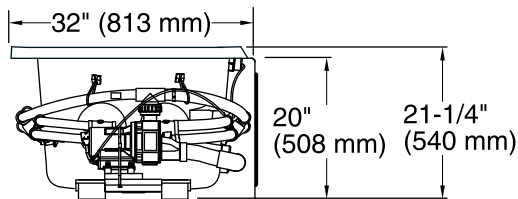

Required Electrical Service

One dedicated circuit required, protected with Class A Ground-Fault Circuit-Interrupter (GFCI). Outside North America, this device may be known as a Residual Current Device (RCD).

Pump: 120 V, 15 A, 50/60 Hz

Technical Information

All product dimensions are nominal.

- Installation: Three-wall alcove
- Drain location: Right
- Basin area, bottom: 42" x 20" (1067 mm x 508 mm)
- Basin area, top: 51" x 24" (1295 mm x 610 mm)
- Weight: 135 lbs (61.2 kg)
- Minimum floor load: 50 lbs/ft² (244.1 kg/m²)
- Water depth: 14" (356 mm)
- Water capacity: 60 gal (227.1 L)
- Electrical component rating: Pump: 120 V, 7 A, 60 Hz
- Minimum flat for door: 2-1/2" (64 mm)

Notes

- Measure your actual product for rough-in details. Install this product according to the installation instructions.
- The hot water supply should be 70% of the capacity of the bath or greater. Installations will vary.
- Provide one grounded electrical outlet within 24" (610 mm) of each component.