

IH75-TS-27209

Prolnox H75

Stainless steel kitchen sink

Handcrafted

Contemporary style corners [0,75"]

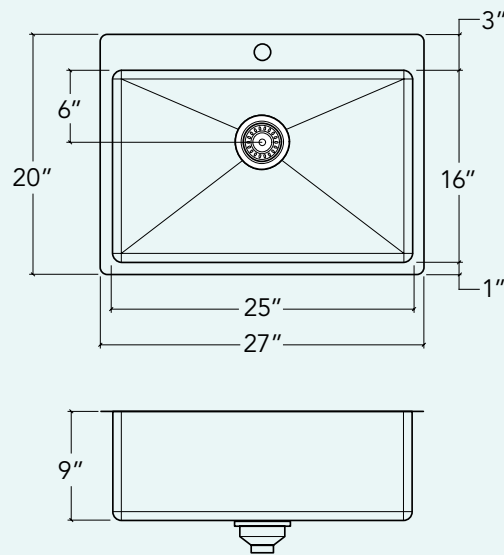

Installation

Topmount

Bowl

25" x 16" x 9"

Overall

27" x 20" x 9"

Recommended cabinet

30"

Drain

Ø 3 1/2"

Packaging

28" x 21 1/2" x 13"

25 lbs

Features

- 304 brushed finish stainless steel (18/10) – 18 gauge
- Single faucet hole (additional holes can be drilled at no charge)
- Sound deadening pads for maximum noise reduction
- Drain located towards rear providing more space under the sink
- Stainless steel strainer (AA-SA-3.5-SA) and mounting hardware included
- Product certified ASME A112.19.3, CSA B45.0, and CSA B45.4

Must-have accessories



Grid
IH-G-2516



Colander
IH-CA-16



Wood cutting board
IH-BA-16-MA

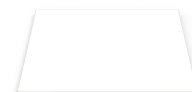

Plastic cutting board
IH-BB-16-WH

Prolnox H75

Topmount installation

Countertop made of laminate, wood, ceramic tile or other solid surface

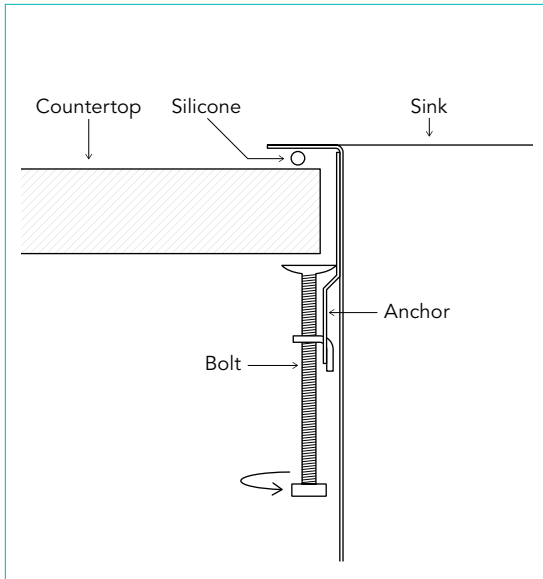

Maintenance

Follow one simple rule to keep your sink in good condition: Clean it regularly.

Daily

Clean the sink with a sponge or a soft cloth.

Use mild soap (dish soap) or an all-purpose, non-abrasive liquid cleanser that contains no chlorines or acid.

Always rinse with warm water and wipe with a dry cloth to prevent calcium buildup.

Use a bottom grid to protect the metal from wear and scratches.

Precautions

Do not scrub the sink with steel wool or scouring pads.

Do not use abrasive cleansers or products containing chlorines or acid.

Do not use silver polish or grout cleaning products, which can discolor the finish and leave stains.

Use a water and vinegar solution to loosen calcium buildup.

Mustard, mayonnaise, lemon juice, grease, fat, and other food residue can cause rust and stains if left to sit. Be sure to rinse your sink with plenty of water.

Do not place a rubber mat on the bottom of your sink. Food, water, and cleaning products can cling to it and create stains.

Warranty

Prochef offers a LIMITED LIFETIME WARRANTY on the fixed components of its stainless steel sinks. This warranty is limited to defects or damages resulting from a normal residential use. For further details on our product warranty, please refer to our catalog or Website.